

EVRO ECONOMY



EVRO ECONOMY

BIURKA / DESKS

szerokość / głębokość / wysokość [cm] width / depth / height [cm]

dostępne blaty o głębokości 80/160 cm (po symbolu dopisujemy 80/160)



EVB 10/11/12-1
140/160/180x70x75h



EVB 13/14/15-1
140/160/180x70x75h

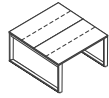

EVB 16/17/18-1
140/160/180x140x75h

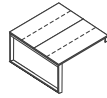

EVB 19/20/21-1
140/160/180x140x75h



EVB 10/11/12-2
140/160/180x70x75h



EVB 13/14/15-2
140/160/180x70x75h

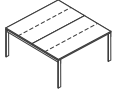

EVB 16/17/18-2
140/160/180x140x75h

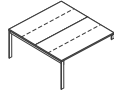

EVB 19/20/21-2
140/160/180x140x75h



EVS 22/23/24-1
140/160/180x70/80x75h



EVS 25/26/27-1
140/160/180x70/80x75h



EVS 28/29/30-1
140/160/180x70/80x75h

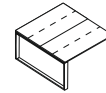

EVS 31/32/33-1
140/160/180x140/160x75h

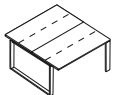

EVS 34/35/36-1
140/160/180x140/160x75h

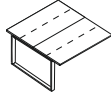

EVS 37/38/39-1
140/160/180x140/160x75h



EVS 22/23/24-2
140/160/180x70/80x75h



EVS 25/26/27-2
140/160/180x70/80x75h



EVS 28/29/30-2
140/160/180x70/80x75h

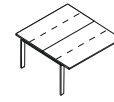

EVS 31/32/33-2
140/160/180x140/160x75h

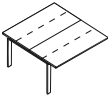

EVS 34/35/36-2

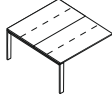

EVS 37/38/39-2
140/160/180x140/160x75h

POMOCNIKI I KONTENERY / SIDE CABINETS AND PEDESTALS

szerokość / głębokość / wysokość [cm] width / depth / height [cm]

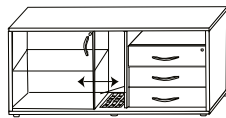

EVP 24
160x55x62,7h

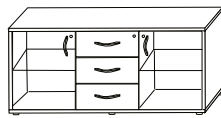

EVP 24
160x55x62,7h

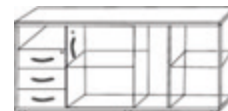

EVP 24
160x55x62,7h



EVK 20
43x70x62,7h
EVK 20/80
43x80x62,7h



EVK 21
43x60x62,7h

EVRO ECONOMY

MEBLE PRACOWNICZE

OPIS TECHNICZNY

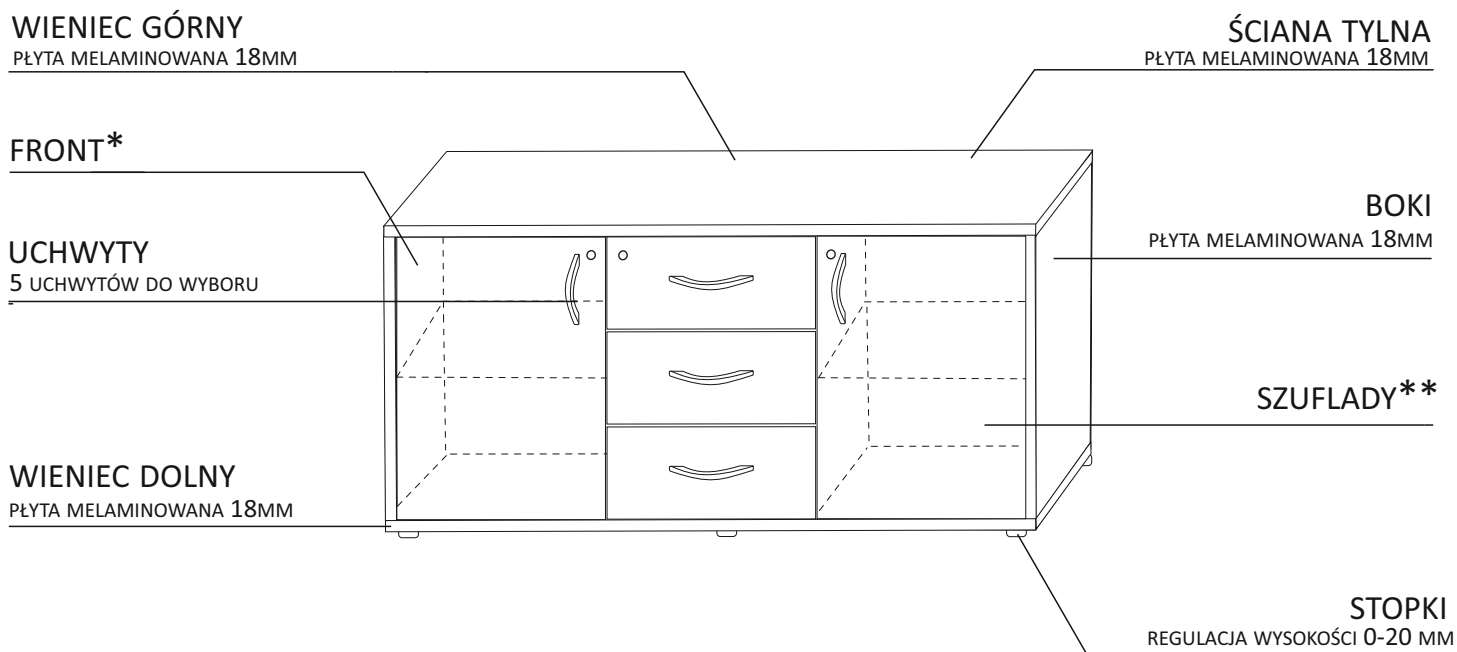
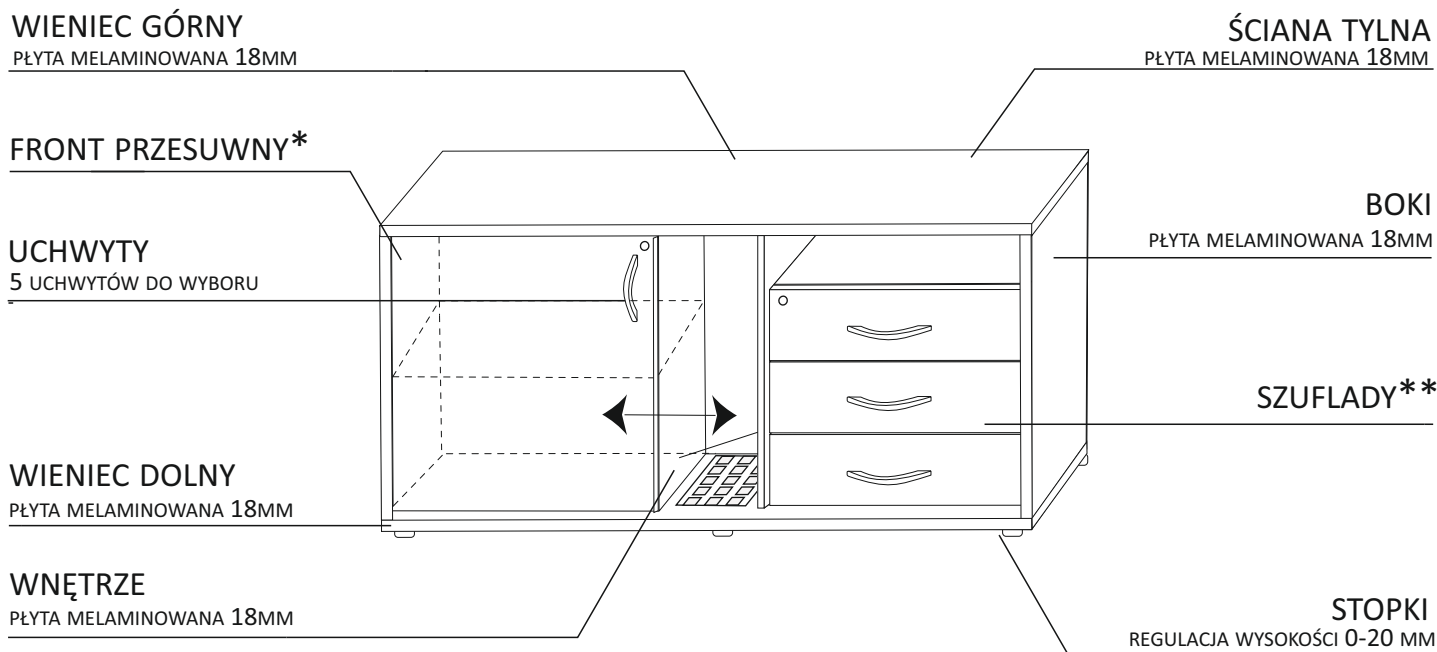

*PŁYTA MELAMINOWANA 18MM, ZAMEK PATENOWY

**FRONT PŁYTA MELAMINOWANA 18MM, PROWADNICE ROLKOWE 3/4 WYSUW, ZAMEK CENTRALNY

EVRO ECONOMY

MEBLE PRACOWNICZE

OPIS TECHNICZNY

