

VICTOR

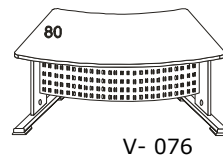

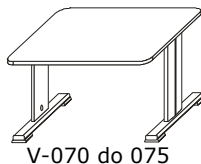

L.p.	Biurka	Płyta 25mm Symbol	Cena netto PLN	Stopy z kanałem kablowym Symbol	Cena netto PLN
1.	80x80x75h	V-010	464,00	V-070	923,00
2.	100x80x75h	V-011	508,00	V-071	990,00
3.	120x80x75h	V-012	553,00	V-072	1 026,00
4.	140x80x75h	V-013	592,00	V-073	1 073,00
5.	160x80x75h	V-014	636,00	V-074	1 113,00
6.	180x80x75h	V-015	678,00	V-075	1 138,00
7.	160x90x75h	V-016	880,00	V- 076	1 773,00

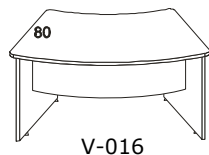
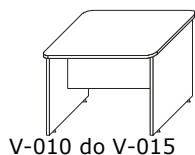
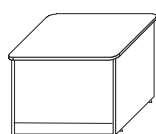

V-040 do V-045

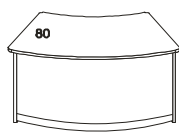

V-046

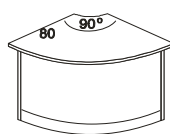

V-047

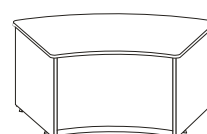

V-048

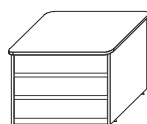

V-040B do V-045B

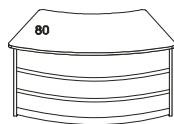

V-046B

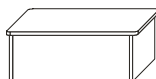

V-060 do V-065



V-066

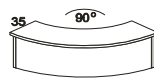

V-067



V-088

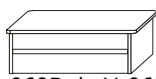

V-060B do V-065B



V-066B

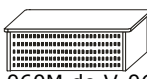

V-060M do V-065M



V-066M



V-067M



V-088M

LADY RECEPCYJNE





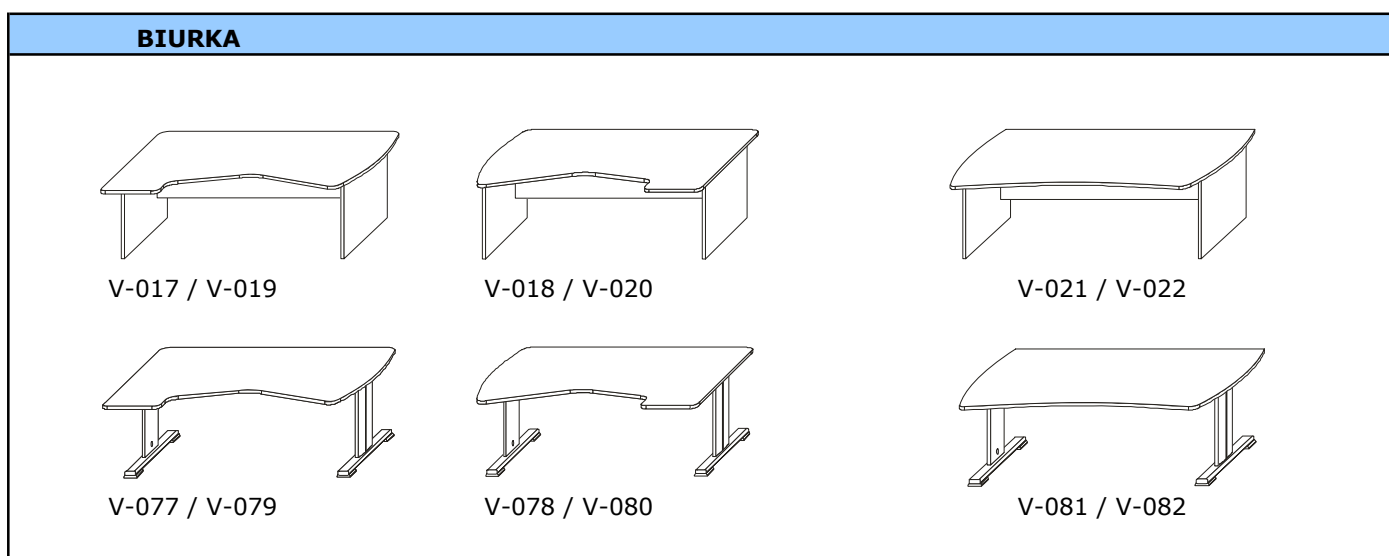

L.p.	Lady - front płyta			Lady - front boniowany		
1.	80x80x75h	V-040	725,00	80x80x75	V-040 B	974,00
2.	100x80x75h	V-041	831,00	100x80x75	V-041 B	1141,00
3.	120x80x75h	V-042	937,00	120x80x75	V-042 B	1305,00
4.	140x80x75h	V-043	1041,00	140x80x75	V-043 B	1466,00
5.	160x80x75h	V-044	1157,00	160x80x75	V-044 B	1641,00
6.	180x80x75h	V-045	1257,00	180x80x75	V-045 B	1802,00
7.	160x90x75h	V-046	2083,00	160x90x75	V-046 B	3344,00
8.	100x100x75h	V-047	1546,00			
9.	160x90x75h	V-048	2036,00			



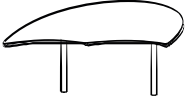

NADSTAWKI RECEPCYJNE O WYSOKOŚCI 35cm							
L.p.		Front płyta		Front boniowany		Front blacha perforowana	
1	80x35x35h	V-060	238,00	V-060 B	379,00	V-060 M	458,00
2	100x35x35h	V-061	276,00	V-061 B	454,00	V-061 M	557,00
3	120x35x35h	V-062	305,00	V-062 B	517,00	V-062 M	643,00
4	140x35x35h	V-063	355,00	V-063 B	602,00	V-063 M	751,00
5	160x35x35h	V-064	395,00	V-064 B	676,00	V-064 M	851,00
6	180x35x35h	V-065	431,00	V-065 B	750,00	V-065 M	947,00
7	160x50x35h	V-066	824,00	V-066 B	1496,00	V-066 M	1418,00
8	100x100x35h	V-067	826,00			V-067 M	1219,00
9	130x50x35h	V-088	790,00			V-088 M	1190,00

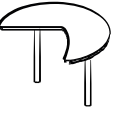
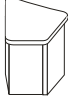
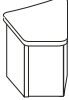
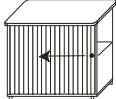
NADSTAWKI RECEPCYJNE O WYSOKOŚCI 46cm							
L.p.		Front płyta		Front boniowany		Front blacha perforowana	
1	80x35x46h	V-060W	258,00	V-060 WB	445,00	V-060 WM	506,00
2	100x35x46h	V-061W	301,00	V-061 WB	530,00	V-061 WM	612,00
3	120x35x46h	V-062W	331,00	V-062 WB	602,00	V-062 WM	708,00
4	140x35x46h	V-063W	384,00	V-063 WB	702,00	V-063 WM	828,00
5	160x35x46h	V-064W	428,00	V-064 WB	786,00	V-064 WM	936,00
6	180x35x46h	V-065W	471,00	V-065 WB	877,00	V-065 WM	1041,00
7	160x50x46h	V-066W	900,00	V-066 WB	1742,00	V-066 WM	1559,00
8	100x100x46h	V-067W	901,00			V-067 WM	1342,00
9	130x50x46h	V-088W	863,00			V-088 WM	1307,00

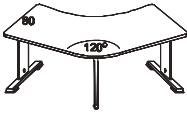

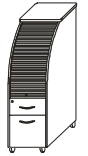
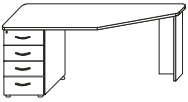
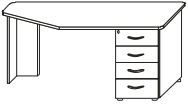
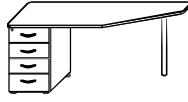
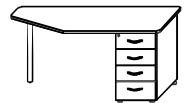
L.p.	Podstawa płyta 25mm	Podstawa stelaż metalowy VICTOR
1.	160x90x75h V-017	754,00 V-077 1140,00
2.	160x90x75h V-018	754,00 V-078 1140,00
3.	180x90x75h V-019	798,00 V-079 1179,00
4.	180x90x75h V-020	798,00 V-080 1179,00
5.	160x85x75h V-021	749,00 V-081 1088,00
6.	180x85x75h V-022	790,00 V-082 1140,00

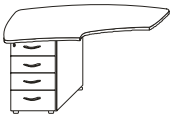
L.P.	ELEMENT	SYMBOL	WYMIAR dłxgłxwys	NAZWA I OPIS		CENA NETTO
						PLN
1.		V-051	ø 120x75h	Dostawka konferencyjna 3/4	do pozycji V-016, V-046, V-076	880,00
2.		V-052	ø 120x75h	Dostawka konferencyjna 3/4		880,00
3.		V-055	172x90x75h	Dostawka łukowa		980,00
4.		V-057	ø 120x75h	Dostawka łukowa	do pozycji od V-017 do V-022, od V-077 do V-082	879,00
5.		V-058	ø 120x75h	Dostawka łukowa		879,00
6.		V-068	56x39x35h	Nadstawka recepcyjna prawa		284,00
		V-068W	56x39x42h			312,00
7.		V-069	56x39x35h	Nadstawka recepcyjna lewa		284,00
		V-069W	56x39x42h			312,00
8.		V-113	90x45x75h	Szafka z żaluzją	zamek w standardzie	1 233,00
9.		V-106	74x60x162h	Szafka kuchenna z żaluzją (mobilna)	możliwość wstawienia lodówki 60 L	3 719,00
14.		V-111	45x45x75h	Kontener	szuflady z płyty	722,00
15.						
16.		V-053	205x120x75h	Biuorko kształtowe 120°		1952,00

L.P.	ELEMENT	SYMBOL	WYMIAR dłxgłxwys	NAZWA I OPIS		CENA NETTO
						PLN
17.		V-104	45x80x75h	Kontener	szuflady z płyty	866,00
18.		V-104 PP			szuflady z tworzywa PP, prowadnica kulkowa, pełen wysuw	1 231,00
19.		V-105	44x60x134h	Szafka mobilna z żaluzją (zamek centralny i zamek żaluzjowy)	szuflady z płyty	1 709,00
20.		V-105 PP			szuflady z tworzywa PP, prowadnica kulkowa, pełen wysuw	1 895,00
21.		V-035	180x50x75h	Dostawka boczna z kontenerem lewa	szuflady z płyty	973,00
22.		V-036	180x50x75h	Dostawka boczna z kontenerem prawa	szuflady z płyty	973,00
23.		V-037	180x50x75h	Dostawka boczna z kontenerem lewa	szuflady z płyty	1 015,00
24.		V-038	180x50x75h	Dostawka boczna z kontenerem prawa	szuflady z płyty	1 015,00
25.		V-112	90x45x75h	Dostawka boczna	szuflady z płyty	928,00
26.		V-115	142x60x75h	Dostawka boczna	szuflady z płyty	1 036,00
27.		V-116	142x60x75h	Dostawka boczna	szuflady z płyty	1 036,00
28.	Lodówka 60L					1 067,00
29.	Chromowanie stóp w stelażu metalowym					554,00
30.	Oświetlenie blatu	cena za 1 metr bieżący oświetlenia LED				260,00
31.		zasilacz				146,00

UWAGI:

Proponowana lodówka jest wstawiana do szafki bez łączenia z drzwiczkami - nie jest to typowa lodówka do zabudowy.